

Class VIII Session 2023-24
Subject - Science
Sample Question Paper - 5

Time Allowed: 3 hours

Maximum Marks: 80

General Instructions:

1. The question paper consists of 34 questions and is divided into four sections, A, B, C and D.
2. All questions are compulsory.
3. Section A comprises question numbers 1 to 15. These are multiple choice questions carrying one mark each. You are to select one most appropriate response out of the four provided options.
4. Section B comprises question numbers 16 to 22. These are SAQs carrying two marks each.
5. Section C comprises question numbers 23 to 31. These are SAQs carrying four marks each.
6. Section D comprises question numbers 32 to 34. These are SAQs carrying five marks each.

Section A

1. Birds can be kept away from field through: [1]
 - a) scarecrows
 - b) wire fences
 - c) spraying pesticides
 - d) spraying weedicides
2. Due to which of the following the disease Measles occur? [1]
 - a) Bacteria
 - b) Helminthens
 - c) Virus
 - d) Parasite
3. CNG is used as fuel because [1]
 - a) none of these
 - b) it is cheaper.
 - c) it is less polluting and easy to transport.
 - d) it has a high density.
4. During combustion temperature rises considerably because burning: [1]
 - a) not uses air
 - b) uses oxygen
 - c) rapidly
 - d) produces light
5. In your opinion which is the most effective way to conserve the plant diversity of an area? [1]
 - a) By creating biosphere reserve
 - b) By developing seed bank
 - c) By tissue culture method
 - d) By creating botanical garden
6. Project tiger was launched to: [1]
 - a) protect tigers of India
 - b) protect and preserve tigers of the world
 - c) protect tigers of India and neighbouring countries
 - d) protect tigers of Asia



17. What is fractional distillation? [2]
18. Discuss the effects of deforestation on the wild animals. [2]
19. What do you mean by secondary sexual characters? [2]
20. Explain why sliding friction is less than static friction. [2]
21. Make a list of materials around you which conduct electricity and a list of those that do not. [2]
22. Suppose you are in a dark room. Can you see objects in the room? Can you see objects outside the room. Explain. [2]

Section C

23. Briefly describe the sprinkler system of irrigation. [4]
24. What are food preservatives? Name some common food preservatives that are used in day-to-day life. [4]
25. Differentiate between combustible and non combustible substances. [4]
26. Describe fertilization in hens? [4]
27. Give reasons: [4]
 - a. School bags should have wider straps.
 - b. A sharp knife cuts better than a blunt knife.
28. How does human produce sound? [4]
29. Demonstrate that lemon juice is a weak conductor of electricity. [4]
30. What are the causes of earthquakes? Explain. [4]
31. Explain the internal structure of human eye. Also discuss the functions of various parts of the eye. [4]

Section D

32. **Read the text carefully and answer the questions:** [5]

Petrol is used as a fuel in light automobiles such as motorcycles/scooters and cars. Heavy motor vehicles like trucks and tractors run on diesel. Petrol and diesel are obtained from a natural resource called petroleum. Petroleum was formed from organisms living in the sea. As these organisms died, their bodies settled at the bottom of the sea and got covered with layers of sand and clay.

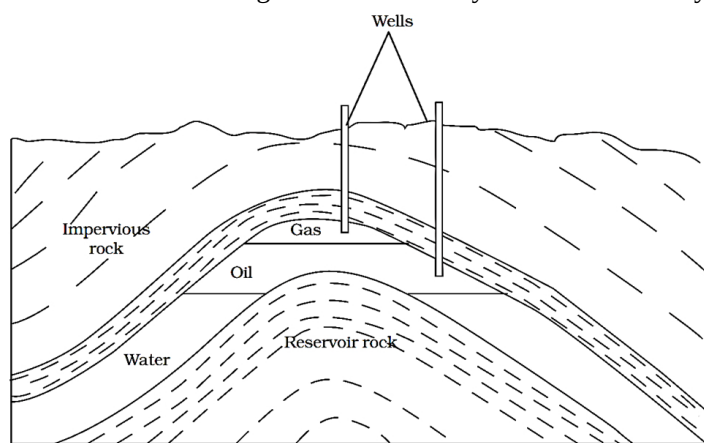

Fig. : Petroleum and natural gas deposits

- (i) Petroleum is also known as

a) black gold	b) coke
c) none of these	d) tar
- (ii) The petroleum product which is not used as fuel is

a) kerosene	b) petroleum jelly
c) diesel	d) petrol

Step 3 - Now, pluck the rubber band somewhere in the middle.

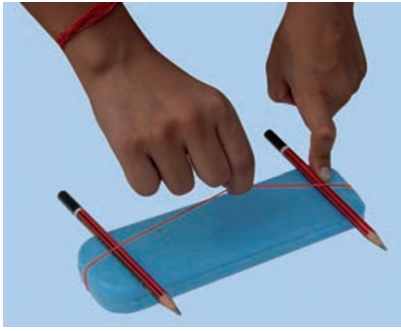

- (i) What is demonstrated by the activity shown above?
- a) All of these
b) Sound is Produced by a vibrating Body
c) Sound needs medium propagation to travel
d) Sound Produced by Humans
- (ii) Which of the following is the musical instruments?
- a) Cymbals
b) All of these
c) Mudpots
d) Ghatam
- (iii) Sound is a kind of
- a) Pressure
b) Energy
c) Force
d) Work
- (iv) The to and fro or back and forth motion of an object is called _____.
- (v) When a tightly stretched band is plucked, it vibrates and produces sound.
- a) True
b) False

Solution

Section A

1. (a) scarecrows

Explanation: Birds can be kept away from fields through scarecrows, which is a hay-man or decoy in the shape of a human. It is usually dressed in old clothes and placed in open field to discourage and terrify birds.

2.

(c) Virus

Explanation: Measles is a highly contagious infectious disease caused by measles virus. Symptoms usually develop 10-12 days after exposure to an infected person and last 7-10 days. Initial symptoms typically include fever, often greater than 40°C (104 °F), cough, runny nose, and inflamed eyes.

3.

(c) it is less polluting and easy to transport.

Explanation: CNG is used as fuel because it is less polluting and easy to transport.

4.

(d) produces light

Explanation: During combustion temperature rises considerably because burning produces heat and light due to the breaking of carbon bonds in them.

5. (a) By creating biosphere reserve

Explanation: By creating biosphere reserve

6. (a) protect tigers of India

Explanation: Project tiger was launched in 1973 in India. The main objective of Project Tiger is to ensure a viable population of tiger in India for scientific, **economic**, aesthetic, cultural, and ecological values.

7.

(d) Gestation

Explanation: The period between fertilization and birth of fully mature child is called gestation. Gestation period varies from animal to animal. In human beings, gestation period is 40 weeks.

8.

(d) Reproductive phase

Explanation: All organism reproduce sexually after certain growth and maturity. That period of growth is called the growth phase which completes at puberty.

9.

(d) Action of force

Explanation: The motion imparted to object is due to the action of force. If force acts on the object along the direction of motion, its speed increases. If force is applied on a direction opposite to the direction of motion, its speed decreases.

10.

(c) Pointed tips

Explanation: The objects with pointed tips will have minimum friction in a fluid. The pointed tips offer less resistance due to less area of contact.

11. (a) Smoothness of surface and nature of surface

Explanation: Friction depends upon the smoothness of surface and nature of surface. Rough surface offers more friction than smooth surface

12.

(b) Wavelength

Explanation: Wavelength

13.

(d) Acid or base



Explanation: Addition of acid, base, or salt or lime juice in distilled water makes it a good conductor of electricity as they provide ions on passing current.

14. (b) Wrath of god visiting them
Explanation: In ancient time, people thought that earthquake and lightning is due to wrath of God visiting them. Later it gets clear that it is due to moving plates of the earth's crust which slide past or collide with one another earthquakes occur and lightning is an electric spark in the sky between oppositely charged clouds.
15. (a) Scatter least
Explanation: Danger signals are made red coloured because red light have longer wavelength that scatter less. Red coloured light can be seen from distance due to less scattering.

Section B

16. a. - iii
b. - iv
c. - ii
d. - i
17. The process by which petroleum is separated into various useful substances which have different boiling points is called fractional distillation.
18. **Wild Animals:** The deforestation leads to the changes in the natural climate or habitat for the animals, so many species will become endangered and ultimately extinct in the near future.
19. The features that help to distinguish the male from the female is called secondary sexual characters. In females, breasts begin to develop and boys begin to grow facial hair.
20. The friction is due to the interlocking of irregularities in the two surface. When the object starts sliding the contact points on its surface, do not get enough time to lock into the contact points on the floor. So the sliding friction is slightly less than the static friction.
21. **Conductors :** Things formed of metals, e.g. copper, iron and aluminium, wet things and solutions of electrolytes in water.
Insulators : Dry things made of wood, rubber and plastics.
22. We can see an object only if light from an object enters our eyes. The light may be emitted by the object or may have been reflected by the object. Thus we cannot see an object which is placed in a dark room if it does not emit light of its own. Whereas an object outside the dark room can be seen if there is either light outside the dark room or the object emits its own light.

Section C

23. In sprinkler system of irrigation, a main pipe is laid in the fields to which perpendicular pipes are joined at regular intervals. When water from a tube-well is allowed to flow through the main pipeline under pressure with the help of a pump, it escapes from the rotating nozzles and gets sprinkled on the crops. This method of irrigation is more useful for the uneven land and sandy soil where sufficient water is not available.



24. The chemical substances which are used to check or stop the growth of harmful microorganisms in food are called food preservatives. These food preservatives keep the edible food materials protected from the invasion of microorganisms which can spoil the food.
- Some common food preservatives are:
- (i) Salt: Common salt is used to preserve meat, fish, amla, raw mangoes and tamarind etc.
 - (ii) Sugar: Jams, jellies and squashes are preserved by sugar. Sugar reduces the moisture contents which inhibit the growth of bacteria which spoil food.
 - (iii) Oil: Edible oils are used as preservatives in vegetables and pickles. Oil does not allow the moisture to surface, thus preventing the growth of harmful bacteria.
 - (iv) Vinegar: It is used to preserve fruits, vegetables, fish, meat and pickles.

25. The difference between combustible and non combustible substances are as follows:

Combustible substances - The substances that catches fire easily to produce heat and light energy is called combustible substance.

The combustible substances are called fuels. Such fuels may be solid, liquid or gas.

Examples of combustible substances are- petrol, kerosene, diesel, coal etc.

Non combustible substances - The substance that does not burn in the presence of air is called non combustible substances.

Such substances are not fuels.

Examples of non combustible substances are - metals, glass, etc.

26. Hen exhibit internal fertilization.

It gets surrounded by many protective sheath or layers including the hard outermost shell made up of the calcareous shell.

After the hard shell is formed around the embryo, the hen lays egg.

The hen then sits on the egg to keep it warm. Development of the chick takes place inside the shell.

It takes about 3 weeks for the embryo to develop in to a chick.

After its development is complete, the chick comes out by bursting open the egg shell.

27. a. A school bag should have wider straps so that the weight of the bag fall over a large area of the shoulder of the child which will produce less pressure on the shoulder of the child. Hence it would be comfortable for the child to carry a heavy bag.

b. A sharp knife has a very thin edge to its blade. It cuts better because due to its very thin edge, the force exerted by our hands will fall over a very small area of the object producing a large pressure that cuts the object easily.

28. Humans communicate with each other by speaking. In humans, the sound producing organ is called larynx or voice box which is present at the upper end of the wind pipe in the throat region. Inside the larynx or voice box there are two vocal cords made up of ligaments, which are stretched across it just like a string. When lungs force out air through larynx, the vocal cords vibrate to produce sound. So whenever we speak or sing, our vocal cords vibrate due to the air expelled from the lungs, producing sound.

29. Collect a few small plastic or rubber caps of discarded bottles and clean them. Pour one teaspoon of lemon juice or vinegar in one cap. Bring your tester over this cap and let the ends of the tester dip into lemon juice or vinegar. Take care that the ends are not more than 1 cm apart but at the same time do not touch each other. When an electric current is passed through vinegar or lemon juice, the bulb glows very dimly which indicates that though vinegar and lemon juice conduct electricity but they are weak conductors of electricity.

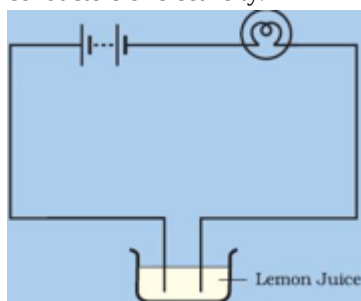

30. We know that the tremors are caused by the disturbance deep down inside the uppermost layer of the earth, called the crust.

The outermost layer of the earth is not in one piece. It is fragmented. Each fragment is called a plate. These plates are in continual motion. When they brush against one another, or collide, or a plate goes under or moves away from another, they cause disturbance in the earth's crust. This disturbance that shows up as an earthquake on the surface of the earth.

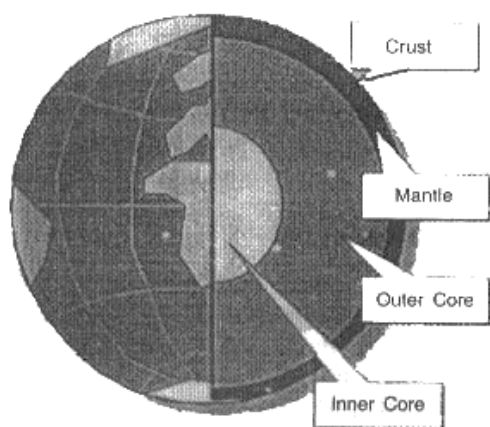

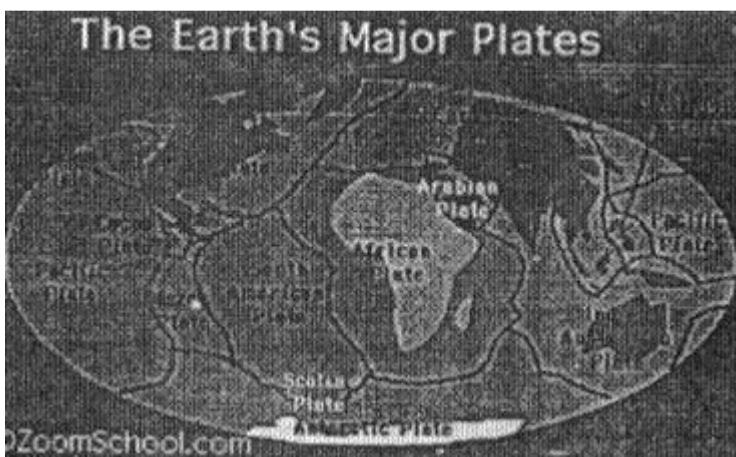

Tremors on the earth can also be caused when a volcano erupts, or a meteor hits the earth, or an underground nuclear explosion is carried out. However most earthquakes are caused by the movement of the earth's plate.

31. i. **Pupil**- The inner aperture that we can see in the centre of the eye is known as pupil. It is like a hole through which light enters the eye.
- ii. **Iris**- It is coloured part of the eye and is involved mainly in controlling the size of pupil. The iris increase and decrease the size of pupil and regulate the amount of light that enters through the pupil.
- iii. **Sclera**- The white part of the eye that we can see is known as sclera. It is filled with a clear watery fluid.
- iv. **Cornea**- It is a thin transparent tissue that covers the front of the eye.
- v. **Retina**- Just behind the eyeball, there is a lining called the retina. It is retina that is sensitive to light and has receptors called rods and cones. The rods and cones respond to light and generate impulses.
- vi. Rods are the cells which are sensitive to dim light.
- vii. Cones are the cells which are sensitive to bright light.
- viii. **Ciliary Muscles**- They controls the focal length of the eye lens.
- ix. **Lens**- It is the transparent tissue between pupil and retina. The lens helps in focusing the light that passes through the pupil into eye. This helps in focusing the image on the retina, by bending the light rays.
- x. **Optic Nerve**- It connects the eye to brain and carries impulse to and from the brain.
- xi. **Blind Spot**- The portion on retina where the nerves fibres enters the optic nerve. This portion does not have any rods and cones. The image falling on this portion of retina cannot be seen. This spot is known as Blind Spot.

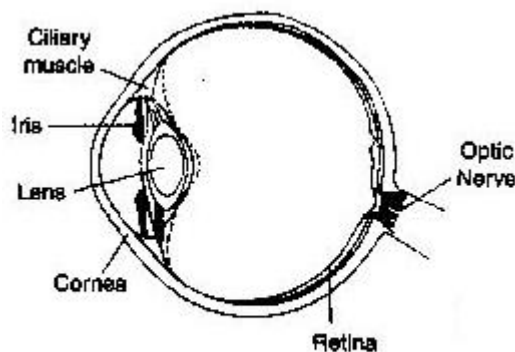

Human eye

Section D

32. **Read the text carefully and answer the questions:**

Petrol is used as a fuel in light automobiles such as motorcycles/scooters and cars. Heavy motor vehicles like trucks and tractors run on diesel. Petrol and diesel are obtained from a natural resource called petroleum. Petroleum was formed from organisms living in the sea. As these organisms died, their bodies settled at the bottom of the sea and got covered with layers of sand and

clay.

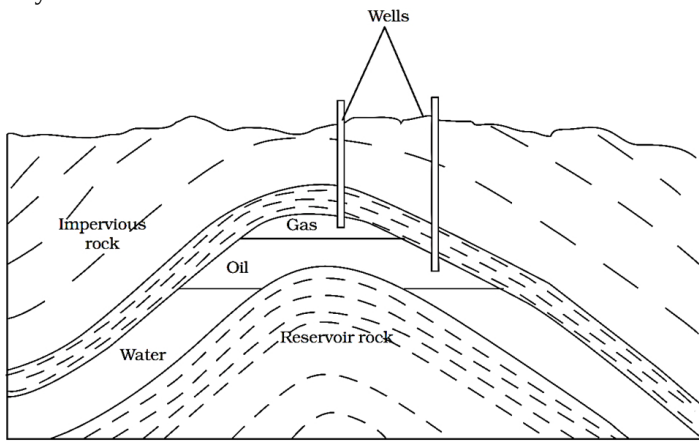

Fig. : Petroleum and natural gas deposits

- (i) **(a)** black gold

Explanation: black gold

- (ii) **(b)** petroleum jelly

Explanation: petroleum jelly

- (iii) **(a)** boiling points

Explanation: boiling points

- (iv) 1. Pennsylvania

- (v) **(a)** True

Explanation: True

33. Read the text carefully and answer the questions:

Rena heard her mother and aunt talking about someone who is going to have a baby. They were discussing whether she would give birth to a boy or a girl. Rena wonder what makes the fertilised egg develop either into a boy or a girl.

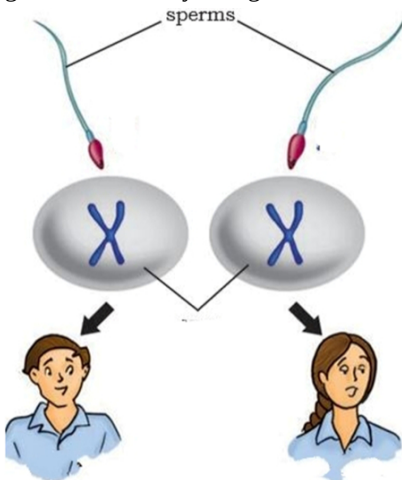

- (i) **(d)** 11 to 19 years

Explanation: 11 to 19 years

- (ii) **(d)** female

Explanation: female

- (iii) **(c)** Chromosomes

Explanation: Chromosomes

- (iv) 1. Sex chromosomes

- (v) **(b)** False

Explanation: False

34. Read the text carefully and answer the questions:

An activity is been demonstrated by the teacher in the class in which she follows the following step

Step 1 - Take a rubber band. Put it around the longer side of a pencil box

Step 2 - Insert two pencils between the box and the stretched rubber.

Step 3 - Now, pluck the rubber band somewhere in the middle.

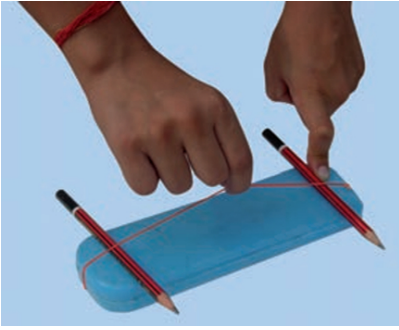

- (i) **(b)** Sound is Produced by a vibrating Body
Explanation: Sound is Produced by a vibrating Body
- (ii) **(b)** All of these
Explanation: All of these
- (iii) **(b)** Energy
Explanation: Energy
- (iv) 1. vibration
- (v) **(a)** True
Explanation: True